

# CARTONI

professional camera support

SLIDE LOCK

MADE IN ITALY

MX0001

PATENTED

TILT  
LOCK

COUNTERBALANCE

BATTERY

MAXIMA

■ product line



**supports  
your  
vision**

Reflecting the **STATE OF THE ART**  
in camera support technology,  
**CARTONI** offers the widest product  
range in the industry.

Over **75 YEARS** of know-how and  
experience, innovative solutions,  
patented technologies and the  
constant care of **SERVING THE**  
**PROFESSIONAL** in any shooting  
situation with any camera, make  
CARTONI synonymous with  
excellence in camera support.

**CARTONI SPA** currently exports  
from **ROME**, its Italian headquarters,  
to seventy countries in five  
continents, with a network of agents  
and distributors serving all major  
international users.

Since 1935, **cartoni**  
has set industry standards,  
which is why the **Academy of  
Motion Pictures Arts & Sciences**  
and **The Society of Operating  
Cameramen**, presented an Award  
to **Dr. Guido Cartoni** for his  
fundamental contribution  
to the industry.

Every part of a CARTONI support system originates from technical research that aims for performance perfection:

The **FLUID DRAG SYSTEM**, with several patents such as the modular labyrinth combination, the variable labyrinth and the planetary fluid control incorporated in the various Fluid Heads. CARTONI camera support heads assure smooth, precise and repeatable movements to a camera.

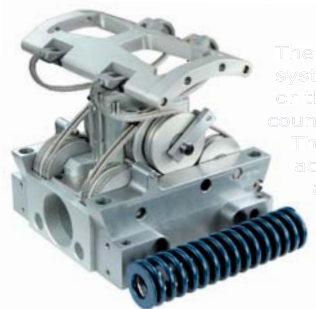

The **COUNTERBALANCE**, with the modular helical spring system, the patented silicon padded variable system or the patented steel cable system allows the perfect counterbalance of the camera throughout the tilt mode.

The camera correct centering is possible thanks to the accurate sliding plates hosting the quick release camera attachment.

The **PORTABLE, LIGHTWEIGHT** and **VERSATILE PEDESTALS** with the innovative design in the pneumatic column allow for torque-free elevation movement.



The **EASY READABLE SETTINGS**, all conveniently placed and assisted by digital readout, and the illuminated spirit level, ensure fast and precise set up.



The **STURDY TRIPODS**, manufactured in special alloys or carbon fiber composites, guarantee absolute stability and virtually no torque effect with their self-adjusting leg coupling and precise and positive height locks.



The **REMOTE CONTROL HEADS** manufactured with sophisticated engineering precision for multiple uses.

The **EXTREMELY STABLE WHEEL UNITS** mounted on 6 high precision bearings.



Constant research and the direct input from the end-user are the secrets of our success.

omega	2
sigma	3
maxima	4
master	5
C40S - C60S	6
C20S	7
dutch head	8
airfloater	9
lambda twin 3D	10
lambda & 3 <sup>rd</sup> axis	11
spinhead	12
smarthead	13
mo-sys lambda	14
e-rem 15	15
e-sensor	16
e-focus	17
delta	18
gamma	19
laser	20
focus HD	21
hidv	22
P90 pedestal	23
P50 - P70 pedestal	24
P20 pedestal	25
jib	26
tripods	27
accessories	32

Designed to support the latest **STUDIO** and **OB** cameras, the **OMEGA** is an extremely compact Fluid Head incorporating a highly precise patented counterbalance system as well as an advanced fluid damping module in both pan and tilt modes.

The **OMEGA** counterbalance mechanism is ideal for camera configurations up to 80 kg (176 lbs) giving a perfect response throughout the tilt range. All settings are connected with a digital read out. The camera is fixed on a V-shaped wedge plate according to international standards and the precise centering of the CG is achieved by a fine tuning crank placed underneath the rear section of the sliding plate.

The **OMEGA** interfaces directly with any flat Mitchell base or 150mm bowl base and can be mounted on top of all existing pedestals featuring the 4-hole bores.

The Fluid Head weighs only 15 kg (33 lbs) and comes equipped with an integrated soft grip carrying handle, two telescopic pan bars, and illuminated spirit level.

## ■ specifications

Payload capacity at:

<b>200 mm (8")</b>	<b>72 Kg (159 lbs)</b>
<b>150 mm (6")</b>	<b>80 Kg (176 lbs)</b>
<b>100 mm (4")</b>	<b>95 Kg (209 lbs)</b>

Weight: **15 Kg (33 lbs)**

Pan range: **360°**

Tilt range: **+/- 65°**

Counterbalance: **Continuous**

Fluid drag: **Continuous**

Bowl diameter: **Flat Mitchell/150mm**

Temp. range: **-40°/+60°C (-40°/+140°F)**

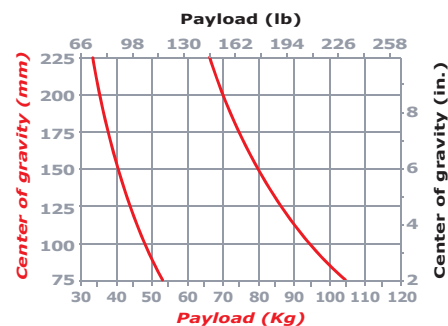

## accessories ■

A 935



A 865



A 951







Designed to support cameras weighing from 10 Kg (22 lbs) to 40 Kg (88 lbs) the **CARTONI SIGMA** combines a wide range of counterbalance capabilities with an outstanding fluid damping system.

The frictionless variable fluid modules perform a wide variety of fluid drag allowing smooth and precise movements in any shooting situation.

**The patented counterbalance system** supports a wide range of payloads at any angle throughout the +/- 90° tilt angle.

All operating knobs and levers are conveniently located and easy to reach with a special care for ergonomics.

The head comes equipped with two telescopic pan bars, illuminated spirit level and digital readouts for drag and counterbalance settings.

In the **35/16MM** Film version the head is supplied with one telescopic pan bar, one front small pan handle and the eye piece extension holder.

## specifications

Payload capacity at:	
200 mm (8")	33 Kg (73 lbs)
150 mm (6")	40 Kg (88 lbs)
100 mm (4")	48 Kg (106 lbs)
Weight:	12 Kg (26 lbs)
Pan range:	360°
Tilt range:	+/- 90°
Counterbalance:	Continuous
Fluid drag:	Continuous
Bowl diameter:	Flat Mitchell/150mm
Temp. range:	-40°/+60°C (-40°/+140°F)



## accessories

A 930



A 903



A 895

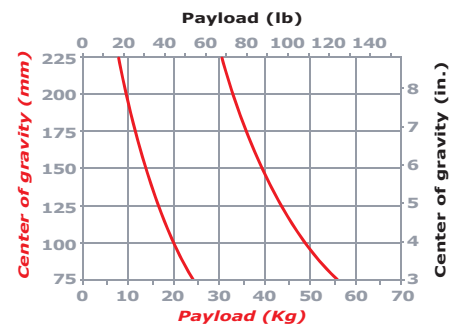

**CARTONI** introduces **MAXIMA**, an innovative compact design Fluid Action Head featuring **an amazingly precise patented counterbalance system**. The MAXIMA is the ideal support for all fully equipped Film Cameras and sophisticated Broadcast packages.

The Maxima controls, knobs and levers, are ergonomically placed to ensure camera operators complete ease-of-use in any situation, whether in the studio, location or during outside broadcasts while drag and counterbalance steps are monitored on a digital display.

Payload capacity goes from **zero (0) to 39 Kg (86 lbs)** with a perfect balance throughout the **entire 180° tilt range**.

The specifically designed **continuous Fluid Drag System** performs from almost freewheeling to extremely consistent drag for maximum versatility. The large sliding camera plate is compatible with Arri and O'Connor slides for increased versatility and ease.

Extremely rugged and precise, the **MAXIMA** is meant to become the **ultimate industry standard**.

### ■ specifications

Payload capacity at:

<b>200 mm (8")</b>	<b>39 Kg (86 lbs)</b>
<b>150 mm (6")</b>	<b>45 Kg (99 lbs)</b>
<b>100 mm (4")</b>	<b>52 Kg (115 lbs)</b>

Weight: **15 Kg (33 lbs)**

Pan range: **360°**

Tilt range: **+/- 90°**

Counterbalance: **Continuous**

Fluid drag: **Continuous**

Bowl diameter: **Flat Mitchell/150mm**

Temp. range: **-40°/+60°C (-40°/+140°F)**

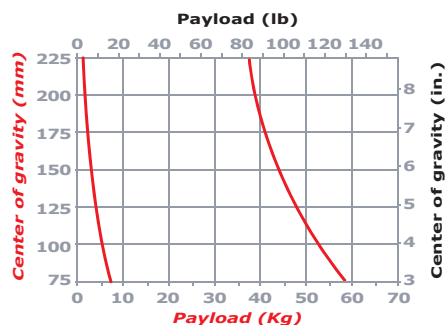

### accessories ■

**A 104**



**A 850/MS**



**C 936**





Designed to support cameras weighing from 10 Kg (22 lbs) to 30 Kg (66 lbs) the **CARTONI MASTER** combines a wide range of counterbalance capabilities with an outstanding fluid damping system.

The frictionless variable fluid modules perform a wide variety of fluid drag allowing smooth and precise movements in any shooting situation.

The **new patented counterbalance system** supports a wide range of payloads at any angle throughout the +/- 90° tilt angle.

All operating knobs and levers are conveniently located and easy to reach with a special care for ergonomics.

The head comes equipped with two telescopic pan bars, illuminated spirit level and digital readouts for drag and counterbalance settings.

## ■ specifications

Payload capacity at:	
200 mm (8")	23 Kg (51 lbs)
150 mm (6")	30 Kg (66 lbs)
100 mm (4")	40 Kg (80 lbs)
Weight:	6,5 Kg (14 lbs)
Pan range:	360°
Tilt range:	+/- 90°
Counterbalance:	Continuous
Fluid drag:	Continuous
Bowl diameter:	Flat Mitchell/150mm
Temp. range:	-40°/+60°C (-40°/+140°F)



## accessories ■

A 933



A 849/M



T 625/R

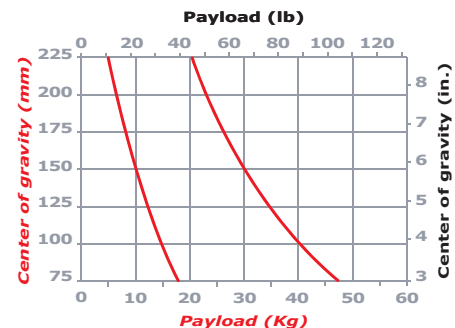

The **C40S** is a heavy duty Fluid Action Head specifically designed to support **FILM** and **STUDIO** cameras.

Counterbalance mechanism is activated by an 8-position easy grip selector, while the fluid control system allows the damping levels to range from "0" for free wheeling to 7 for maximum drag on both pan and tilt modes.

Standard features include the quick-release camera plate with safety lock, two adaptable telescopic pan bars and illuminated spirit level. The head comes equipped with a flat Mitchell base, and options include a **150MM** bowl base and the eye piece extension holder.

For **STUDIO/OB** configurations weighing up to 55 Kg (121 lbs), **C60S** offers an extremely cost-effective option. **C40S** and **C60S** interface directly with the Studio tripod series or the Heavy Duty tripods for extra ruggedness.

### ■ specifications

Payload capacity **C40S** at:

<b>200 mm</b> (8")	<b>39 Kg</b> (86 lbs)
<b>150 mm</b> (6")	<b>45 Kg</b> (99 lbs)
<b>100 mm</b> (4")	<b>54 Kg</b> (119 lbs)

Payload capacity **C60S** at:

<b>200 mm</b> (8")	<b>45 Kg</b> (99 lbs)
<b>150 mm</b> (6")	<b>55 Kg</b> (121 lbs)
<b>100 mm</b> (4")	<b>65 Kg</b> (143 lbs)

Weight: **11 Kg** (24 lbs)

Pan range: **360°**

Tilt range: **+/- 65°**

Counterbalance **C40S** : **7 steps + 0**

Counterbalance **C60S**: **4 steps + 0**

Fluid drag: **7 + 7**

Bowl diameter: **Flat Mitchell/150mm**

Temp. range: **-40°/+60°C (-40°/+140°F)**

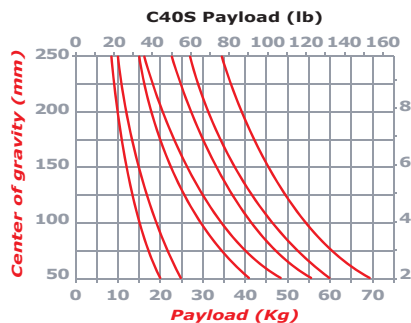

### accessories ■

**A 849**



**A 850/C 4**



**A 891**







Designed to provide an extremely stable support for standard **EFP** configurations, the **C20S** is ready to operate with a wide range of cameras weighing from 7 to 25 Kg (15 to 55 lbs).

**C20S features three award winning fluid damping modules** assuring outstanding drag levels and extraordinary smoothness in both pan and tilt modes.

Movements can be selected with 7 precisely repeatable steps of drag, while free wheeling is available by simply setting the drag selector ring into position "0".

Counterbalance is activated by an easy grip selector in 7 progressive steps and "0".

The **C20S** comes with a 100mm bowl base, illuminated spirit level and two telescopic pan bars. A 150 mm bowl base is also available as an option.

## ■ specifications

Payload capacity at:		
200 mm (8")	20 Kg (44 lbs)	
150 mm (6")	25 Kg (55 lbs)	
100 mm (4")	32 Kg (71 lbs)	
Weight:	6,5 Kg (14 lbs)	
Pan range:	360°	
Tilt range:	+/- 65°	
Counterbalance:	7 steps + 0	
Fluid drag:	7 + 7	
Bowl diameter:	100/150mm	
Temp. range:	-40°/+60°C (-40°/+140°F)	



## accessories ■

A 850/C 2



A 845



D 734

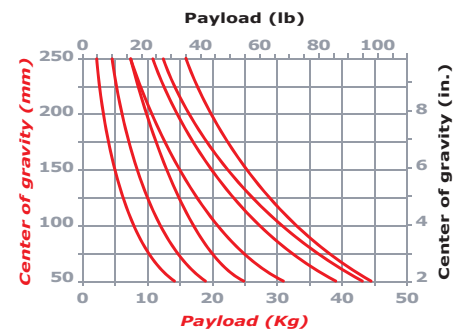

This special accessory has been conceived to add a 3rd axis to a standard Fluid Head and allow the lateral movement called "Dutch angle", enhancing special effects.

Available in **C20S** and **C40S** size the **CARTONI DUTCH HEAD** is designed to make exceptionally smooth side-tilt effects simple and straightforward to execute.

The **DUTCH HEADS** integrate the award-winning **CARTONI** fluid module in progression from "0" to 7 intensity. The counterbalance system features the 7 step spring mechanism.

In both versions **CARTONI DUTCH HEADS** interface directly with the quick release plate on the top of the main Fluid Head, and with the same size camera plate to attach the camera assembly.

A special telescopic pan bar completes the equipment.

## ■ specifications

### **C20S** Dutch Head:

Payload capacity: **25 Kg (55lbs)**

Weight: **5 Kg (11 lbs)**

Tilt range: **+/- 65°**

Counterbalance: **7 steps + 0**

Fluid drag: **7settings + 0**

Base: **120x80x7mm plate**

Temp. range: **-40°/+60°C (-40°/+140°F)**

### **C40S** Dutch Head:

Payload capacity: **45 Kg (100 lbs)**

Weight: **8 Kg (17 lbs)**

Tilt range: **+/- 65°**

Counterbalance: **7 steps + 0**

Fluid drag: **7settings + 0**

Base: **120x80x7mm plate**

Temp. range: **-40°/+60°C (-40°/+140°F)**



## ■ accessories

### **C 911**



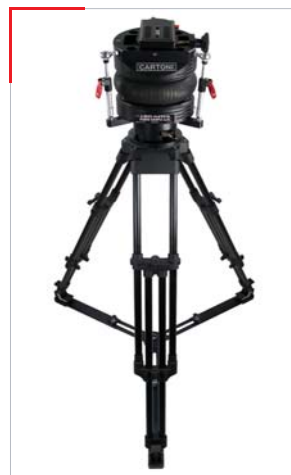

The Patented **AIRFLOATER** manufactured in Italy under licence by **CARTONI** is designed to avoid straining the Cameraman's back and shoulders simulating active shoulder-shots, realistic points of view and total freedom of movement.

Even with the heaviest camera configuration the **AIRFLOATER** is incredibly easy to handle and operate.

**You can pan a full 360° and tilt 18°** in any direction The red "locks" levers are used to lock the the tilt.

The **AIRFLOATER** is equipped with a variety of base attachments: Chapman/Whitworth bolt, 4 bore Vinten holes, 300mm Mitchell with castle nut.

The platform of The **AIRFLOATER** is a Quick-Release European Base plate.

The **AIRFLOATER** has nearly the same dimensions as a conventional Fluid Head.

An optional sturdy waterproof case with compartments for bases, camera plates and tools is available upon request.

### ■ specifications

Payload capacity:	<b>150 Kg (330 lbs)</b>
Weight:	<b>15 Kg (33 lbs)</b>
Height:	<b>25 cm (10")</b>
Width:	<b>34 cm (13")</b>
Head attachment:	<b>Flat Mitchell standard</b>

### accessories ■

**C 936**



**CARTONI designed the first Nodal pan & tilt Professional Support for 3D Rigs in the world.**

**CARTONI** applied decades of experience gained in designing and manufacturing Professional Camera Supports by expanding the **bestselling Lambda "Nodal Swing Head" concept to 3D Rig** requirements designed for parallel stereoscopic & beam splitter shooting styles with full-sized HD cameras like Alexa, F3, Genesis, Red One, Epic, F35, just to name a few.

Providing operational flexibility the **LAMBDA TWIN 3D** can be fitted to a range of supports, including heavy-duty tripods, dollies, cranes and camera cars.

The **LAMBDA TWIN 3D** can be inverted in under-slung position for low line positioning and allow 3D Rigs to be positioned all the way to the ground. Its unique nodal capability allows the coincidence of the optical plan with the rotation center and the CG.

The **LAMBDA TWIN 3D** employs a patented **CARTONI** fluid drag control system, micrometric sliding vertical plates, positive locks on all movements.

Several rosettes and 3/8" threads are easily accessible in multiple different locations on the head for pan bar, counterweights and accessories attachment.

The **LAMBDA TWIN 3D** features a swinging camera platform in **"U" shape**, equipped with a sliding base.

## ■ specifications

Payload capacity: **up to 50 Kg (110 lbs)**

Weight: **45 Kg (99 lbs)**

Inside width: **60 cm (24")**

Maximum height for Rig clearance: **70 cm (28")**

Pan range: **360°**

Tilt range: **360°**

Head attachment: **Flat Mitchell standard with castle nut**







The **LAMBDA** is the "NODAL SWING HEAD" ideally suited for **35MM** film cameras fully equipped with long lenses, mattebox and extra large film magazines.

Providing a high level of operational flexibility, this Fluid Head can be easily fitted to a wide range of supports including tripods, dollies, cranes and camera cars. The mounting can be inverted in under-slung position for low line positioning and allow the camera to be moved all the way to the ground and provide for accurate images which normally cannot be obtained with other traditional supports.

The balance system is designed so that the camera may swing on its center of gravity and **ROTATE 360°** on its vertical axis. No springs or similar counter reaction elements are required to set the head in a fixed tilt position and fluid pan and tilt movements have the same identical feel. The lens focal distance can be kept constant by presetting the fore and aft horizontal sliding plate.

The **LAMBDA** employs the patented **CARTONI** fluid drag control system on both pan and tilt modes. In order to obtain the **3<sup>RD</sup> AXIS** rotation, the **LAMBDA** features the 3<sup>rd</sup> Axis accessory comprising an additional fluid drag system with 7 steps + "0".

A variety of accessories as the orientable extendable pan bar, the round steering wheel, the 150mm bowl base, the counterweights and rods for nodal setting complete the equipment.

3<sup>rd</sup> axis

## accessories ■

A 833/L



A 890



A 850/L



## ■ specifications

Payload capacity:	<b>40 Kg (88 lbs)</b>
Weight:	<b>21 Kg (46 lbs)</b>
3rd Axis weight:	<b>15,5 Kg (35 lbs)</b>
Pan range:	<b>360°</b>
Tilt range:	<b>360°</b>
3rd Axis range:	<b>360°</b>
Fluid drag:	<b>7+7</b>
Bowl diameter:	<b>Flat Mitchell/150mm</b>
Temp. range:	<b>-40°/+60°C (-40°/+140°F)</b>

This new **CARTONI SPINHEAD** is an innovative and unique support Head for any film or video camera weighing up to 15 kg (33lbs).

Its "L" shape configuration allows to operate at **NODAL SETTING** (coincidence of the rotation center with the optical center) on a tripod, on a dolly, on camera cars, underslung from a crane or jib arm.

Both pan and tilt movements are assisted by **CARTONI** patented continuous fluid drag units.

These fluid drag modules are hollow in the center in order to allow cables and plugs. The unique and patented feature is a spinning tilt unit which offsets the camera allowing to pivot the camera plate for **360°** degrees and lock it at any angle you may desire.

All settings are easily accessible and comfortable to operate, the camera can be centered on board with micrometric cranks. The camera attachment is achieved by a quick release long dovetail plate or alternatively with a cinestyle european quick release camera plate.

Also, available as an optional kit, a **REMOTE CONTROL MOTORIZED VERSION** for additional versatility.

### ■ specifications

Load capacity: **15 kg (33 lbs)**

Weight: **10kg (22 lbs)**

Pan range: **360°**

Tilt range: **360°**

Spin range: **360°**

Temp. range: **-40°/+60°C (-40°/+140°F)**

Fluid drag: **Continuous**

Base: **Flat Mitchell standard, compatible with Vinten 4 holes, 150mm**

### accessories ■

**A 918**



As the junior member of the **CARTONI** "L" shaped Heads, **SMARTHEAD** offers an outstanding new tool to videographers.

**SMARTHEAD** is a highly Professional **NODAL HEAD**, including precision cranks to perfectly balance the camera weight.

It features 3 drag settings in both pan and tilt mode as well as the zero drag for freewheeling, a quick release sliding camera plate, positive locks and 2 level bubbles.

**SMARTHEAD** comes equipped with an extendable main pan bar, a short front panbar, counterweights for balance on the main pan bar. Counterweights for Nodal Setting available as an option.

The **SMARTHEAD** can be used on a tripod as any fluid head, but also underslung, hanging from a jib arm or a crane for table-top shooting.

#### ■ specifications

Load capacity: 5 kg (11 lbs)

Weight: 6 kg (13 lbs)

Pan range: 360°

Tilt range: 360°

Temp. range: -40°/+60°C (-40°/+140°F)

Fluid drag: 3 + 0

Base: 100mm bowl



The **MO-SYS LAMBDA** motion control camera support head shares all the advantages and versatility of the regular **CARTONI LAMBDA** head. It features un-compromised, zero-backlash drive mechanics for precision, power and low maintenance.

Built in cooperation with **MO-SYS** (Motion Systems Technology Ltd) this state of the art equipment can be used for many different operations and configurations.

The head can be mounted on a variety of supports as tripod, cranes or dollies and the system can be completed with the 3-axis Lens Control Module, which is compatible with most digital lens motors.

**With its embedded processors and a specific menu driven software, there is no need to lug around an external PC.**

Programming is extremely simple and can be learned in one hour, and moves can be recorded live, in real time, using hand wheels, pan bar, joystick, or using key-frames.

**The exact motion is stored in internal, non-volatile memory.**

It can be replayed again and again, at any speed, re-recorded, exported to post-production or modified. Another grip-friendly method is "manual mode", where physical maneuvering of the axes is recorded for future playback.

## ■ specifications

Capacity: **30 Kg (66 lbs)**

Head weight: **30 Kg (66 lbs)**

Max Pan Speed: **180 deg/sec**

Power requirement: **15-30V DC**

Playback speed settable from 0,03% to 600% of original recorded speed.

Input devices settings for Hand wheels, Force-sensitive pan bar, Remote pan bar, Joystick, Key frame.

Move back up and export with easy to use, Windows based PC software with USB interface.

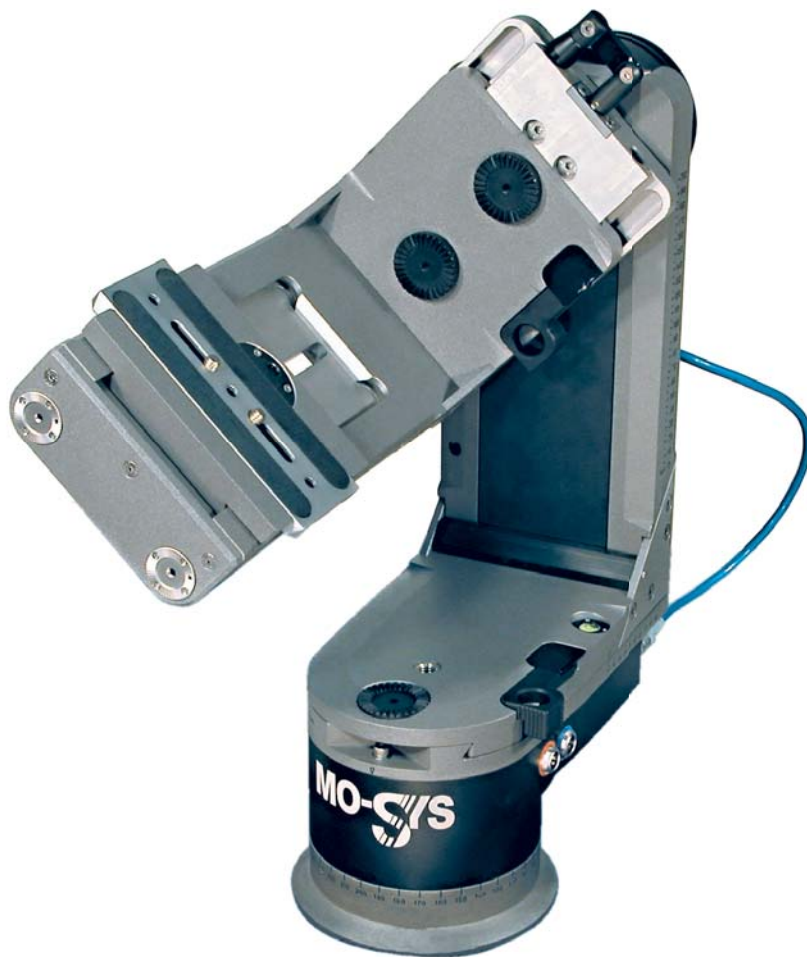

## accessories ■

T 624



C 920







## accessories

A 928



Console



e-FOCUS



This new **CARTONI REMOTE CONTROL HEAD** engineered in partnership with UK's **MO-SYS LTD** - is for cameras and camcorders up to 15kg (33 lbs). Slipping-free, innovative cable routing and sleek design together with an affordable price makes the **e-rem 15** a highly competitive product.

Manufactured with sophisticated engineering precision the **e-rem 15** has multiple uses:

- Remote controlled head on top of cranes
- Virtual studios with position data output
- Multiple camera control for broadcasting

**e-rem 15** can be operated with a joystick, slaveheads as the **CARTONI e-FOCUS** & **e-SENSOR**, handwheel set. A variety of shotbox options enable the different configurations



## specifications

Payload capacity: 15 kg (33 lbs)

Weight: 8 kg (17,5 lbs)

Pan range: 360°

Tilt range: 360°

Base: Flat

The latest response to encoded support as needed in the **VIRTUAL REALITY** shooting.

Strong, versatile, including all features of a standard **CARTONI** fluid action camera support head, the **e-SENSOR** features extremely high resolution direct sensing encoders in both pan and tilt, absolute positioning with no need to re-calibrate at start up, built-in electronic, simple cabling; a single cable supplies both power and data, with a range of up to 100m.

**CARTONI e-SENSOR** is powered by **MO-SYS** (Motion Systems Technology Ltd) and is compatible with most 3D packages for real time camera/scene movement in virtual set and pre-visualization, it is the ideal solution for sports 3D graphic insertions plus it is compatible with all **MO-SYS** control systems as an input device.

Connectors for lens encoders and other position sensors information are also possible to integrate to the **e-SENSOR** electronics, making it a very versatile contender on the virtual set.

## ■ specifications

Payload capacity: **30 Kg (66 lbs)**

Weight: **6,5 Kg (14 lbs)**

Pan range: **360°**

Tilt range: **+/- 90°**

Counterbalance: **7 steps +0**

Fluid drag: **Continuous**

Bowl diameter: **100mm**

Pan resolution: **> 1 million counts/rev**

Tilt resolution: **> 1 million counts/rev**

Positioning: **absolute**

Encoding transmission: **Direct - no gears.  
Single cable for  
power and  
position data**



## accessories ■

T 623



C 936



A 847





Created in response to the need for a small self-contained Fluid Head with built-in tracking encoders, the **e-FOCUS** is a compact yet extremely precise and performant camera support ideal in **VIRTUAL REALITY** shooting and position tracking.

The **CARTONI e-FOCUS** features high resolution encoders for direct sensing in both pan and tilt, absolute positioning with no need to re-calibrate at start up, single cable for both power and data supply.

**e-FOCUS** is compatible with most **3D** softwares for real time camera/scene movements in **virtual sets, previsualisation and 3D animation**.

Extremely compact and light weight the **e-FOCUS** operates with continuously variable fluid damping modules in both pan and tilt movements and an unprecedented patented counterbalance system which covers all existing **DV** and **ENG** cameras.

## specifications

Payload capacity:	1-10kg (2.2-22 lbs)
Weight:	3,5 kg (7.7 lbs)
Pan range:	360°
Tilt range:	+/- 90°
Counterbalance	Continuous
Fluid drag:	Continuous
Bowl diameter:	100mm
Tilt resolution:	> 1 million counts/rev
Pan resolution:	> 1 million counts/rev
Positioning:	Absolute
Encoding transmission:	Direct, no gears. Single cable for Power and positioning data



## accessories

D 734



T 627



C 928



Ideal for supporting **ENG** dockable camcorders or **EFP** cameras equipped with long focal lenses and top mounted viewfinders, the **DELTA** is manufactured with an extensive use of ultra-light magnesium alloy.

The fully variable counterbalance system is designed to accommodate offset payloads of 22 Kg (48 lbs) ensuring excellent performances at any tilt angle.

The **DELTA** features a **continuously adjustable fluid damping mechanism** providing extremely smooth and precise camera movements.

Standard performances of +70, -60 degrees, with the European style quick attachment camera plate, can be increased to +/- 90 ° with the optional sliding base plate.

Powered by a 9v battery, two digital displays indicate the counterbalance and tilt drag values, while an illuminated spirit level allows easy set-up even in low light conditions.

■ specifications

Payload capacity at:  
**150 mm (6")**                    **17 Kg (37 lbs)**  
**100 mm (4")**                    **22 Kg (49 lbs)**

Weight: **3,5 Kg (7.7 lbs)**

Pan range: **360°**

Tilt range: **+/- 90° with sliding base plate**  
**+70°/-60° with quick attachment plate**

Counterbalance: **Continuous**

Fluid drag: **Continuous**

Bowl diameter: **100 mm**

Temp. range: **-40°/+60°C (-40°/+140°F)**

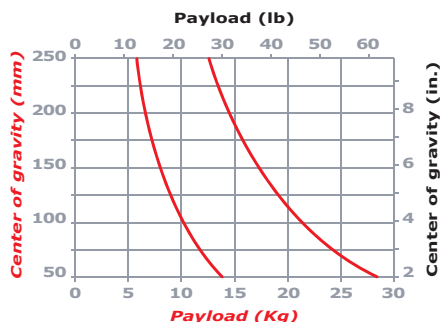

accessories ■







Safe and reliable, the **GAMMA** support is specifically designed for **ENG** configurations up to 17 Kg (37 lbs).

Featuring an infinitely variable counterbalance system with easy readable numerical reference, the **GAMMA** provides excellent performances at any angle from +90 to -70 degrees. For additional tilt matching the -90° angle, an ultra light sliding plate is available.

A host of advanced features make this **FLUID HEAD** a bestseller in its range including infinitely adjustable drag settings, camera quick release system and illuminated spirit level.

The **GAMMA** head interfaces with a wide range of 100 mm bowl tripods both in aluminum or carbon fiber with either single or double stage extension.

### ■ specifications

Payload capacity at:  
**150 mm (6")** 13 Kg (29 lbs)  
**100 mm (4")** 17 Kg (37 lbs)

Weight: 3,5 Kg (7.7 lbs)

Pan range: 360°

Tilt range: +/- 90°  
 with sliding base plate  
 +90°/-70°  
 with quick attachment plate

Counterbalance: Continuous

Fluid drag: Continuous

Bowl diameter: 100 mm

Temp. range: -40°/+60°C (-40°/+140°F)



### accessories ■

S 731/SML

D 734

C 928

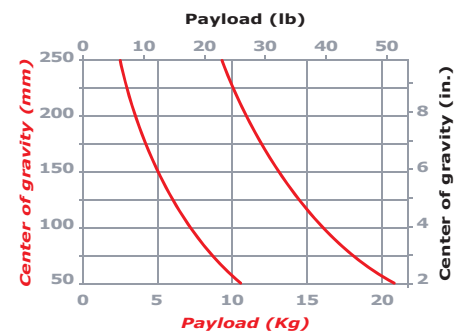

Built of magnesium and aluminum alloy, the **LASER** is a very compact and lightweight Fluid Head designed for portable **DIGITAL CAMERAS** weighing up to 15 Kg (33 lbs).

Featuring an infinitely variable counterbalance, the **LASER** provides for excellent performances at any tilt position from +90 to -90 degrees.

The continuously variable fluid control system ensures consistent drag levels and smooth camera movements on both pan and tit modes.

The **LASER** comes equipped with a 100 mm bowl base, telescopic pan bar and illuminated spirit level.

A wide range of **ENG** tripods are available both in aluminum or carbon fiber version with either single or double stage extension.



■ specifications

Payload capacity at:	
150 mm (6")	12 Kg (26 lbs)
100 mm (4")	15 Kg (33 lbs)

Weight: 3 Kg (7 lbs)

Pan range: 360°

Tilt range: +/- 90°

Counterbalance: Continuous

Fluid drag: Continuous

Bowl diameter: 100 mm

Temp. range: -40°/+60°C (-40°/+140°F)

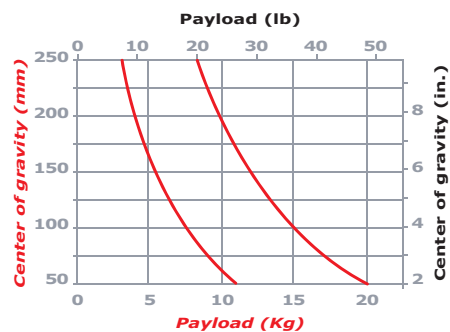

accessories



D 734



C 928





The **FOCUS HD** head is the ideal support for the latest **HDV** cameras weighing from 0 to 12 Kg (0 to 26 lbs). Extremely compact and lightweight, the innovative **FOCUS HD** features a continuously variable fluid damping system on both pan and tilt movements and a unprecedented patented variable counterbalance which brings its range of use to cover all existing **ENG** and **HDV** cameras.

The **FOCUS HD** head comes equipped with a quick release sliding camera plate, illuminated spirit level and orientable pan bar. Its tilting angle is +/- 90° with perfect response throughout the entire tilt range.

It interfaces with all 100mm bowl base tripods and supports. The extreme ruggedness and versatility together with an outstanding quality/price ratio make the **FOCUS HD** the best possible support for **NEWS** operators and **HDV** videographers.

### ■ specifications

Payload capacity at:	
150 mm (6")	10 Kg (22 lbs)
100 mm (4")	12 Kg (26 lbs)
Weight:	2 Kg (4.4 lbs)
Pan range:	360°
Tilt range:	+/- 90°
Counterbalance:	Continuous
Fluid drag:	Continuous
Bowl diameter:	100 mm
Temp. range:	-40°/+60°C (-40°/+140°F)



### accessories ■

D 733



A 841/A



C 928

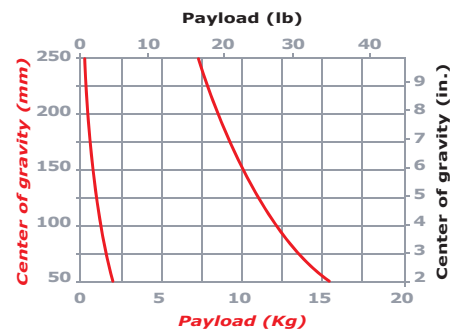

The **HIDV FLUID HEAD** is the ideal support for the latest DV cameras weighing from up to 6 Kg (13 lbs). Extremely compact and lightweight the **HIDV** features a continuously variable fluid damping system on both pan and tilt movements a unprecedented **CARTONI** patented **VARIABLE COUNTERBALANCE** which brings its range of use to cover all existing **DV** and **HDSLR** cameras.

The **HIDV** Fluid Head comes equippe with a quick release sliding camera plate, spirit level and orientable pan bar. The **HIDV**'s tilting angle is +/- 90° with perfect response throughout the entire tilt range.

It interfaces with all 75mm bowl base tripods and supports. The extreme ruggedness and versatility together with a superb quality/price ratio make the **HIDV** the best possible support for DV videographers.

### ■ specifications

Payload capacity at:

**150 mm (6")**      **5 Kg (11 lbs)**  
**100 mm (4")**      **6 Kg (13 lbs)**

Weight: **1,8 Kg (4 lbs)**

Pan range: **360°**

Tilt range: **+/- 90°**

Counterbalance: **Continuous**

Fluid drag: **Continuous**

Bowl diameter: **75mm**

Temp. range: **-40°/+60°C (-40°/+140°F)**

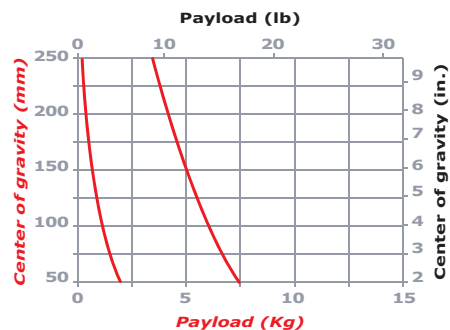

### accessories ■

**D 733**



**T 626/2**



**C 928**







Extremely versatile, the **CARTONI P90** two-stage pedestal is designed to support camera/lens combination up to 90 Kg, covering the entire range of **STUDIO** and **OB** configurations.

The system is compact and portable, the 2-stage column performs an "on-shot stroke" of 74 cm with a smooth and precise movement.

**The sturdy and yet lightweight dolly** is equipped with high precision double wheels interlocked by a special designed chain allowing accurate travelling and steering, even on shot. Pneumatic bigger wheels are also available as an option.

The **CRAB POSITION** is also available for narrow door ways. All operating devices and control displays are at the cameraman easy access.

The pneumatic column works on simple compressed air which can be loaded with a compressor or a simple hand pump.

The system interfaces with all flat base, 4-bore holes heads or any other bowl based head with an adapter.

Available in "classic black" - Special order only.

## ■ specifications

Maximum pressure: **13.0 atm (187 psi)**

Maximum capacity: **90 Kg (198 lbs)**

Total weight: **60 Kg (132 lbs)**

"on-shot" stroke: **74 cm (29")**

Steering wheel diameter: **57,5 cm (22,6")**

Minimum height: **72 cm (28,4")**

Maximum height: **146 cm (57,5")**

Wheel diameter: **125 cm (49,2")**

Doorway tracking width: **80 cm (31,4")**

Dolly leg radius: **47,5 cm (18,7")**

Column weight: **30 Kg (66 lbs)**

Dolly weight: **30 Kg (66 lbs)**

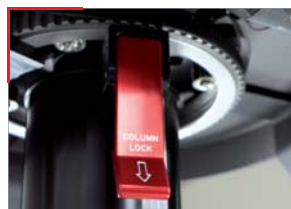

**P50** is a portable and compact system for both **STUDIO** and **OB** applications. Extremely stable yet lightweight, its ideal performance is reached with camera/lens combination of around 55 kg (121 lbs). In the **P70** version the payload capacity is extended to 65 Kg (145 lbs).

The air filled, one shot column is fast and safe to operate: the air can be set in manually or by compressor, and a safety air pressure valve prevents danger of over pumping.

The innovative column design provides outstanding stability end jerk-free control with exceptional smoothness and precise movements.

**On the foldable dolly, six position track lock**, foot operated brake on each of the 125mm twin wheels and cable guards provide smooth movements in any desired direction.

The column is firmly secured to the dolly by a double clamp, easily engaged by two ergonomic locking levers. A set of 200mm **PNEUMATIC TIRES** with wheel brakes are available for OB use.

### ■ specifications

Maximum pressure **P50**: 17.0 atm (250 psi)

Maximum pressure **P70**: 12.2 atm (175 psi)

Maximum capacity **P50**: 55 Kg (121 lbs)

Maximum capacity **P70**: 65 Kg (145 lbs)

Total weight **P50**: 28 Kg (62 lbs)

Total weight **P70**: 28 Kg (62 lbs)

"on-shot" stroke: 50 cm (19,7")

Dolly leg radius: 50 cm (19,7")

Steering wheel diameter: 45 cm (17,7")

Minimum height: 75 cm (30")

Maximum height: 140 cm (55,1")

Wheels: 3 x 2 coupled

Wheel diameter: 125 mm (5")

Doorway tracking width: 100 cm (39,4")



### accessories ■

A 106



A 867



A 940



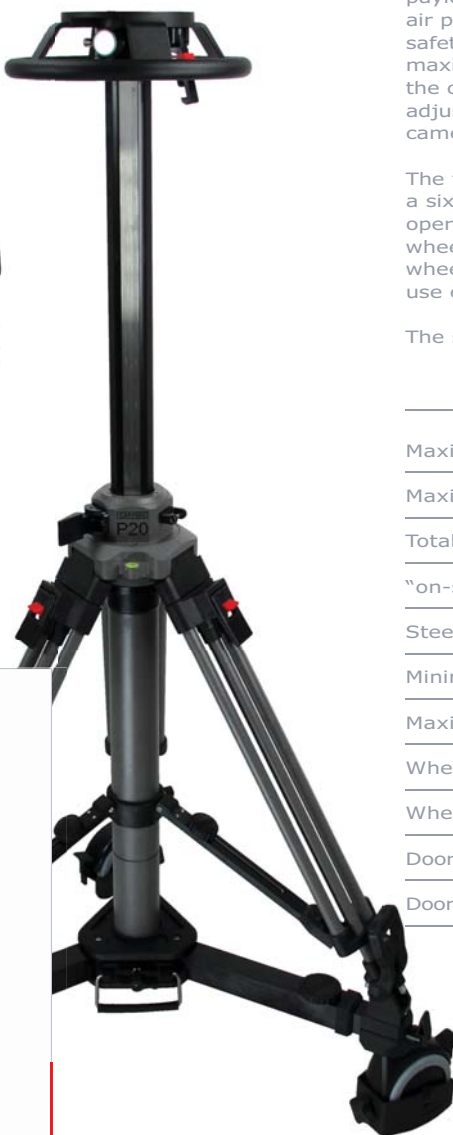

Extremely compact and lightweight, this **INNOVATIVE PEDESTAL** is the ideal mate for mobile work and lightweight studio needs.

The same technical concept which has made the **P50** so successful is performed in the **CARTONI P20**, an extremely rugged and precise dolly and a pneumatic column for maximum stability, smoothness and jerk-free operation.

The column supports a maximum payload of 25Kg (55 lbs) it includes an air pressure gauge, locking brake and safety air pressure valve adjusted at maximum 187 psi. The air pressure inside the column can be set in manually and adjusted to suit the exact weight of the camera configuration.

The foldable and extensible dolly features a six-position **TRACK LOCK**, foot operated brake on each of the 100mm wheel and cable guards. Special track wheels, available as an option allow the use on standard tracks

The system includes a manual air pump.

### specifications

Maximum pressure: **13.0 atm (187 psi)**

Maximum capacity: **25 Kg (55 lbs)**

Total weight: **14 Kg (31 lbs)**

"on-shot" stroke: **40 cm (15,7")**

Steering wheel diameter: **26 cm (10,2")**

Minimum height: **74 cm (29")**

Maximum height: **161 cm (63,3")**

Wheels: **3 x 2 coupled**

Wheel diameter: **100mm (3,9")**

Doorway tracking width min.: **67 cm (26,3")**

Doorway tracking width max.: **97 cm (38,1")**

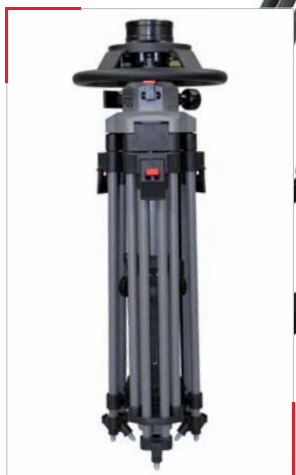

### accessories

A 866

A 869



A 831



Designed to carry up to 7 kg (15 lbs) the **CARTONI JIB** is one of the most versatile and cost effective lightweight portable jibs.

Assembled in less than five minutes the Jib adds the benefit of diagonal tracking and elevation to the traditional pan and tilt movement of a standard Fluid Head.

The **JIB** weighs only 9 Kg (20 lbs), folds down to 1 meter (39") in length and permits shooting from absolute ground level to 2 meters (78") in height.

The rear part of the arm, which holds the counterweights, is extendable to provide for **accurate camera balance**, while the front telescopic arm allows the Jib to work in wide variety of shooting requirements.

Standard configuration includes a 100mm bowl base head attachment with double orientation, left to right and on/under, spirit level and 10 kg (22 lbs) counterweights.

The **JIB** interfaces with any 100mm bowl base tripod.



Focus HD



HiDV



## ■ specifications

Payload capacity: **7 Kg (15 lbs)**

Weight: **9 Kg (20 lbs)**

Pan range: **360°**

Maximum extension: **2 mt (78")**

Minimum extension: **1 mt (38")**

Bowl base diameter: **100mm**



## accessories ■

D 734



A 922 - w/A 921



A 950







**OB & STUDIO TRIPODS**

With its rugged construction and extraordinary sturdiness the Cartoni Studio and Heavy Duty tripods are designed to support the larger Fluid Heads in Studio or Outside Broadcast configuration.

A special care has been developed in achieving torsional rigidity and positive leg clamp. The tripod series feature both flat Mitchell style bases including the 4 hole bores and 150mm bowl base.

The ground steel spikes are covered by adjustable rubber feet and each tripod can be secured either by an integral off ground spreader or by a variety of ground spreaders and skids.

	624/S		Short		T 625/M	T 625/S	T 625/SM
<b>STUDIO</b>	Baby 1 stage	Short 1 stage	Short 1 stage	1 stage	1 stage	Short 1 stage	Short 1 stage
<b>Material</b>	Aluminum	Aluminum	Aluminum	Aluminum	Aluminum	Aluminum	Carbon Fiber
<b>Load capacity</b>	150 Kg 330 lbs	150 Kg 330 lbs	150 Kg 330 lbs	200 Kg 440 lbs	200 Kg 440 lbs	200 Kg 440 lbs	200 Kg 440 lbs
<b>Weight</b>	6,3 Kg / 13,8 lbs	5,01 Kg / 11 lbs	5,1 Kg / 11,2 lbs	11,2 Kg / 24,7 lbs	11,3 Kg / 24,9 lbs	9,1 Kg / 20 lbs	9,2 Kg / 20,2 lbs
Mid-Level Spreader	9 Kg / 19,8 lbs			13,8 Kg / 30,4 lbs	14 Kg / 30,8 lbs	12,3 Kg / 27,1 lbs	12,4 Kg / 27,3 lbs
Ground Spreader	8,2 Kg / 18 lbs			13,1 Kg / 28,8 lbs	13,3 Kg / 29,3 lbs	11,6 Kg / 25,5 lbs	11,7 Kg / 25,8 lbs
<b>Max height</b>		47 cm / 18,5"	47 cm / 18,5"				
Mid-Level Spreader	80 cm / 31,5"			137 cm / 53,9"	137 cm / 53,9"	75 cm / 29,5"	75 cm / 29,5"
Ground Spreader	87,5 cm / 34,4"			141 cm / 55,5"	141 cm / 55,5"	80 cm / 31,4"	80 cm / 31,4"
<b>Min height</b>		26 cm / 10,2"	26 cm / 10,2"				
Mid-Level Spreader	43 cm / 16,9"			79 cm / 31,1"	79 cm / 31,1"	39 cm / 15,3"	39 cm / 15,3"
Ground Spreader	48 cm / 18,9"			72,5 cm / 28,5"	72,5 cm / 28,5"	47 cm / 18,5"	47 cm / 18,5"
<b>Folded height</b>		35 cm / 13,7"	35 cm / 13,7"				
Mid-Level Spreader	63 cm / 24,8"			99 cm / 38,9"	99 cm / 38,9"	68 cm / 26,7"	68 cm / 26,7"
Ground Spreader	60 cm / 23,6"			89,5 cm / 35,2"	89,5 cm / 35,2"	59 cm / 23,2"	59 cm / 23,2"
<b>Bowl diameter</b>	Flat	150 mm	Flat	150 mm	Flat	Flat	150 mm

Product Code	T 625/2	T 625/2M	T 625/E
<b>HEAVY DUTY</b>	2 stage	2 stage	stage Elevation Unit
<b>Material</b>	Alluminum	Alluminum	Alluminum
<b>Load capacity</b>	200 Kg 440 lbs	200 Kg 440 lbs	200 Kg 440 lbs
<b>Weight</b>	13,9 Kg / 30,6 lbs	14 Kg / 30,8 lbs	16,6 Kg / 36,6 lbs
Mid-Level Spreader	17 Kg / 37,4 lbs	17,1 Kg / 37,7 lbs	20,4 Kg / 44,9 lbs
Ground Spreader	16,5 Kg / 36,3 lbs	16,6 Kg / 36,6 lbs	19,3 Kg / 42,5 lbs
<b>Max height</b>			
Mid-Level Spreader	160 cm / 62,9"	160 cm / 62,9"	105-143 cm/41,3"-56,3"
Ground Spreader	156 cm / 61,4"	156 cm / 61,4"	116-154 cm/45,6"-60,6"
<b>Min height</b>			
Mid-Level Spreader	70 cm / 27,5"	70 cm / 27,5"	58-95 cm/22,8"-37,8"
Ground Spreader	60 cm / 23,6"	60 cm / 23,6"	58-96 cm/22,8"-37,8"
<b>Folded height</b>			86 cm / 33,8"
Mid-Level Spreader	90 cm / 35,4"	90 cm / 35,4"	
Ground Spreader	80 cm / 31,5"	80 cm / 31,5"	
<b>Bowl diameter</b>	150 mm	Flat	Elevation Unit



**ELEVATION UNIT**

This sturdy support is suitable for both Studio and Maxi tripods, and combines the height range advantages of a standard pedestal with the low cost, robustness and fast operation of a tripod.

Weighing only 4 Kg (4,4 lbs), it features a maximum elevation height of 35 cm (14") and can be easily mounted on any existing platform equipped with the 4-holes bore.

**EFP TRIPODS**

Stable and sturdy, though lightweight, the Cartoni EFP series tripods are available in one or two stages and both in aluminum and carbon fiber.

The 100mm bowl base is connected to the three legs with a performing system of elastic washers and self adjusting steel connection which guarantees virtually no torque effect even with heavy drag fluids.

Height adjustment is performed by a fast clamp, and includes a safety lock to prevent accidental falls.

The bottom foot includes both a threaded spike and the loop clamp, receiving the adjustable rubber foot and interfaces with dollies and ground spreaders.



Product Code	T 623/C	T 623/2	T 623/2C	T 623/B	T 623/S	T 624	T 624/M
<b>EFP/STUDIO</b>	1 stage	2 stage	2 stage	Baby 1 stage	Short 1 stage	1 stage	1 stage
<b>Material</b>	Carbon Fiber	Alluminum	Carbon Fiber	Alluminum	Alluminum	Alluminum	Alluminum
<b>Load capacity</b>	80 Kg 176 lbs	80 Kg 176 lbs	80 Kg 176 lbs	80 Kg 176 lbs	80 Kg 176 lbs	150 Kg 330 lbs	150 Kg 330 lbs
<b>Weight</b>	3,2 Kg / 7,0 lbs	4,0 Kg / 8,8 lbs	3,9 Kg / 8,6 lbs	2,8 Kg / 6,1 lbs	2,7 Kg / 5,9 lbs	7,3 Kg / 16 lbs	7,4 Kg / 16,3 lbs
Mid-Level Spreader	3,95 Kg / 8,7 lbs	4,75 Kg / 10,4 lbs	4,6 Kg / 10,1 lbs	3,56 Kg / 7,8 lbs	.....	10,2 Kg / 22,4 lbs	10,3 Kg / 22,7 lbs
Ground Spreader	4,4 Kg / 9,7 lbs	5,27 Kg / 11,6 lbs	5,1 Kg / 11,2 lbs	4 Kg / 8,8 lbs	.....	9,8 Kg / 21,6 lbs	9,9 Kg / 21,8 lbs
<b>Max height</b>					47 cm / 18,5"		
Mid-Level Spreader	139 cm / 54,7"	145 cm / 57"	145 cm / 57"	71,5 cm / 28,1"		138 cm / 54,3"	138 cm / 54,3"
Ground Spreader	144,5 cm / 56,8"	153,5 cm / 60,4"	153,5 cm / 60,4"	81,5 cm / 32"		155 cm / 61"	155 cm / 61"
<b>Min height</b>					31 cm 12,2"		
Mid-Level Spreader	76 cm / 29,9"	62 cm / 24,4"	62 cm / 24,4"	31 cm / 12,2"		82 cm / 32,3"	82 cm / 32,3"
Ground Spreader	68 cm / 26,7"	48 cm / 18,9"	48 cm / 18,9"	44,5 cm / 17,5"		79,5 cm / 31,3"	79,5 cm / 31,3"
<b>Folded height</b>					37 cm / 14,5"		
Mid-Level Spreader	87,5 cm / 14,4"	74 cm / 29,1"	74 cm / 29,1"	57,5 cm / 22,6"		98 cm / 38,5"	98 cm / 38,5"
Ground Spreader	86 cm / 33,8"	72 cm / 28,3"	72 cm / 28,3"	56 cm / 22"		95 cm / 37,4"	95 cm / 37,4"
<b>Bowl diameter</b>	100 mm	100 mm	100 mm	100 mm	100 mm	150 mm	Flat

**CARTONI DOLLIES**

The **DOLLIES** are designed and manufactured with the highest quality alloys. All wheel groups are assembled with high precision bearings and equipped with positive individual locks. Each wheel group can be locked in 6 different **positions at 60°** allowing a smooth precise translational movement even without tracks.

**STUDIO UNITS** come equipped with cableguards.

Product code	D733	D 734 D 734/A	D 737	D 736	D 736/P
<b>DOLLIES</b>	Alluminum	Alluminum	Alluminum	Alluminum	Alluminum
<b>Material</b>	Lightweight	Standard	Studio	Heavy Duty	Heavy Duty OB
<b>Load capacity</b>	60kg/132lbs	100kg/220lbs	200kg/440lbs	200kg/440lbs	200kg/440lbs
<b>Weight</b>	3,3kg/7,26lbs	5,7kg/12,54lbs	12kg/28lbs	13Kg/29lbs	15kg/33lbs
<b>Wheel diameter</b>	7,5 cm	10 cm	12,5 cm	12,5 cm	20 cm
<b>Leg radius</b>	47 cm	50 cm	50 cm	50 cm	50 cm
<b>Height</b>	11,5 cm	33-50 cm 22 cm	25 cm	25 cm	28 cm



**3-WAY LEVELLER HD TRIPOD**

A unique Heavy Duty tripod with flat Mitchell base and 3-way levelling ability for horizontal fine tuning. The innovative concept allows mounting all flat Mitchell base heads and still be able to correct horizontal plan without acting on the legs height and without compromise for torsional rigidity.

T 625/R



Product Code	T 624/C	T 624/CM	T 624/2	T 624/2M	T 624/2C	T 624/2CM	T 624/B
<b>STUDIO</b>	1 stage	1 stage	2 stage	2 stage	2 stage	2 stage	Baby 1 stage
<b>Material</b>	Carbon Fiber	Carbon Fiber	Alluminum	Alluminum	Carbon Fiber	Carbon Fiber	Alluminum
<b>Load capacity</b>	150 Kg 330 lbs	150 Kg 330 lbs	150 Kg 330 lbs	150 Kg 330 lbs	150 Kg 330 lbs	150 Kg 330 lbs	150 Kg 330 lbs
<b>Weight</b>	6,3 Kg / 13,6 lbs	6,4 Kg / 13,8 lbs	6,8 Kg / 15 lbs	6,9 Kg / 16,2 lbs	6,2 Kg / 13,6 lbs	6,3 Kg / 13,8 lbs	6,2 Kg / 13,6 lbs
Mid-Level Spreader	9,3 Kg / 20,3 lbs	9,4 Kg / 20,5 lbs	9,6 Kg / 21,6 lbs	9,7 Kg / 21,3 lbs	8,8 Kg / 19,4 lbs	8,9 Kg / 19,6 lbs	8,9 Kg / 19,6 lbs
Ground Spreader	8,3 Kg / 18,9 lbs	8,4 Kg / 19,1 lbs	9,06 Kg / 19,9 lbs	9,1 Kg / 20 lbs	8,5 Kg / 18,7 lbs	8,6 Kg / 18,9 lbs	8,09 Kg / 17,8 lbs
<b>Max height</b>							
Mid-Level Spreader	138 cm / 54,3	138 cm / 54,3	142 cm / 55,9"	142 cm / 55,9"	142 cm / 55,9"	142 cm / 55,9"	80 cm / 31,5"
Ground Spreader	155 cm / 61"	155 cm / 61"	163 cm / 64,1"	163 cm / 64,1"	163 cm / 64,1"	163 cm / 64,1"	87,5 cm / 34,4"
<b>Min height</b>							
Mid-Level Spreader	82 cm / 32,3"	82 cm / 32,3"	57,5 cm / 22,6"	57,5 cm / 22,6"	57,5 cm / 22,6"	57,5 cm / 22,6"	43 cm / 16,9"
Ground Spreader	79,5 cm / 31,3"	79,5 cm / 31,3"	50 cm / 19,6"	50 cm / 19,6"	50 cm / 19,6"	50 cm / 19,6"	48 cm / 18,9"
<b>Folded height</b>							
Mid-Level Spreader	98 cm / 38,5"	98 cm / 38,5"	76 cm / 29,9"	76 cm / 29,9"	76 cm / 29,9"	76 cm / 29,9"	63 cm / 24,8"
Ground Spreader	95 cm / 37,4"	95 cm / 37,4"	73 cm / 28,7"	73 cm / 28,7"	73 cm / 28,7"	73 cm / 28,7"	60 cm / 23,6"
<b>Bowl diameter</b>	150 mm	Flat	150 mm	Flat	150 mm	Flat	Flat - 150 mm

## ENG TRIPODS

Lightweight and extreme stability, together with a fast display in action, are the main features of the ENG tripods.

Available in three versions: the basic 3 tubes, the classic ENG one stage and the double stage, all available in lightweight aluminum or ultra-light carbon fiber.

Height adjustment is performed by a fast, easy to reach clamp and includes a safety lock to prevent accidental falls.

The bottom foot includes a threaded spike receiving the adjustable rubber foot and interfaces with dollies and ground spreaders.



Product Code	T 621			T 627/C	T 627/2	T 622	T 622/C
<b>DV &amp; ENG</b>	1 stage 3 tube	2 stage 3 tube	1 stage 3 tube	1 stage 3 tube	2 stage 3 tube	1 stage	1 stage
<b>Material</b>	Aluminum	Aluminum	Aluminum	Carbon Fiber	Aluminum	Aluminum	Carbon Fiber
<b>Load capacity</b>	40 Kg 88 lbs	40 Kg 88 lbs	50 Kg 110 lbs	50 Kg 110 lbs	50 Kg 110 lbs	60 Kg 132 lbs	60 Kg 132 lbs
<b>Weight</b>	1,9 Kg / 4,2 lbs	2,7 Kg / 5,9 lbs	2,5 Kg / 5,5 lbs	2,3 Kg / 5,0 lbs	3,1 Kg / 6,8 lbs	2,6 Kg / 5,7 lbs	2,5 Kg / 5,5 lbs
Mid-Level Spreader	2,45 Kg / 5,4 lbs	3,4 Kg / 7,5 lbs	3,27 Kg / 7,2 lbs	2,99 Kg / 6,6 lbs	3,8 Kg / 8,3 lbs	3,4 Kg / 7,5 lbs	3,27 Kg / 7,2 lbs
Ground Spreader	3,04 Kg / 6,7 lbs	3,92 Kg / 8,6 lbs	3,72 Kg / 8,2 lbs	3,44 Kg / 7,6 lbs	4,3 Kg / 9,4 lbs	3,8 Kg / 8,3 lbs	3,7 Kg / 8,1 lbs
<b>Max height</b>							
Mid-Level Spreader	136 cm / 53,5"	154,5 cm / 60,8"	143 cm / 56,3"	143 cm / 56,3"	155 cm / 61"	138 cm / 54,3"	138 cm / 54,3"
Ground Spreader	141 cm / 55,5"	160,5 / 63,2"	147 cm / 57,8"	147 cm / 57,8"	161,5 cm / 63,5"	143,5 cm / 56,5"	143,5 cm / 56,5"
<b>Min height</b>							
Mid-Level Spreader	79,5 cm / 31,3"	69 cm / 27,1"	76 cm / 29,9"	76 cm / 29,9"	70 cm / 27,5"	74,5 cm / 29,3"	74,5 cm / 29,3"
Ground Spreader	64 cm / 25,2"	56 cm / 22"	67,5 cm / 26,5"	67,5 cm / 26,5"	57 cm / 22,4"	67 cm / 26,3"	67 cm / 26,3"
<b>Folded height</b>							
Mid-Level Spreader	85 cm / 33,4"	79,5 cm / 31,3"	87,5 cm / 34,4"	87,5 cm / 34,4"	80 cm / 31,5"	87 cm / 34,2"	87 cm / 34,2"
Ground Spreader	83 cm / 32,6"	77 cm / 30,3"	85 cm / 33,4"	85 cm / 33,4"	77,5 cm / 30,5"	84,5 cm / 33,2"	84,5 cm / 33,2"
<b>Bowl diameter</b>	75 mm	75 mm	100 mm	100 mm	100 mm	100 mm	100 mm





Product Code	T 622/2	T 622/2	Smart Stop	Smart Stop	Baby	Short	T 623
<b>DV &amp; ENG</b>	2 stage	2 stage	2 stage	2 stage	1 stage	1 stage	1 stage
<b>Material</b>	Alluminum	Carbon Fiber	Alluminum	Carbon Fiber	Alluminum	Alluminum	Alluminum
<b>Load capacity</b>	60 Kg 132 lbs	60 Kg 132 lbs	60 Kg 132 lbs	60 Kg 132 lbs	60 Kg 132 lbs	60 Kg 132 lbs	80 Kg 176 lbs
<b>Weight</b>	3,2 Kg / 7,0 lbs	3,0 Kg / 6,6 lbs	3,1 Kg / 6,8 lbs	2,9 Kg / 6,4 lbs	2,2 Kg / 4,8 lbs	2,1 Kg / 4,8 lbs	3,4 Kg / 7,5 lbs
Mid-Level Spreader	3,9 Kg / 8,6 lbs	3,74 Kg / 8,2 lbs	3,8 Kg / 8,3 lbs	3,65 Kg / 8,0 lbs	2,9 Kg / 6,4 lbs		4,1 Kg / 9 lbs
Ground Spreader	4,43 Kg / 9,7 lbs	4,26 Kg / 9,4 lbs	4,3 Kg / 9,4 lbs	4,150 Kg / 9,1 lbs	3,38 Kg / 7,4 lbs		4,6 Kg / 10,1 lbs
<b>Max height</b>						47 cm / 18,5"	
Mid-Level Spreader	153 cm / 60,2"	153 cm / 60,2"	147 cm / 57,8"	147 cm / 57,8"	70,5 cm / 27,7"		139 cm / 54,7"
Ground Spreader	161 cm / 63,3"	161 cm / 63,3"	155 cm / 61"	155 cm / 61"	81 cm / 31,8"		144,5 cm / 56,8"
<b>Min height</b>						30 cm / 11,8"	
Mid-Level Spreader	65 cm / 25,6"	65 cm / 25,6"	61,5 cm / 24,2"	61,5 cm / 24,2"	30 cm / 11,8"		76 cm / 29,9"
Ground Spreader	51 cm / 20"	51 cm / 20"	45,5 cm / 17,9"	45,5 cm / 17,9"	43,5 cm / 17,1"		68 cm / 26,7"
<b>Folded height</b>						37 cm / 14,5"	
Mid-Level Spreader	76,5 cm / 30,1"	76,5 cm / 30,1"	73 cm / 28,7"	73 cm / 28,7"	57 cm / 22,4"		87,5 cm / 14,4"
Ground Spreader	74 cm / 29,1"	74 cm / 29,1"	71 cm / 27,9"	71 cm / 27,9"	54,5 cm / 21,4"		86 cm / 33,8"
<b>Bowl diameter</b>	100 mm	100 mm	100 mm	100 mm	100 mm	100 mm	100 mm

**S 708**  
mid level spreader



**S 732**  
standard ground spreader



**S 732/HD**  
heavy duty spreader



**D 733**  
lightweight dolly



**S 731/ML**  
multi level spreader



**S 732/F**  
flexible ground spreader



**S 732/HDML**  
heavy duty mid level spreader



**D 734**  
standard dolly



**S 731/SQR**  
mid level spreader



**S 738**  
studio spreader



**S 732/HDMLA**  
heavy duty mid level spreader 2 stage



**D 734/A**  
extendable dolly



■ **D 736 A**  
studio extendable dolly



■ **D 737**  
studio dolly



■ **A 891**  
3-way leveller



■ **A 845**  
100mm bazooka basket



■ **A 846 M**  
bazooka basket mitchell base



■ **A 847**  
100mm hi-hat



■ **A 848**  
150mm high hat



■ **A 852**  
45° wedge plate



■ **A 106**  
flat mitchell base leveller



■ **A 863 -A 863-150**  
100mm - 150mm head adapter  
to P50



■ **A 869**  
100mm head adapter to P20



■ **A 907**  
mitchell nut flat base



■ **A 856**  
flat base 4-bore holes adapter



■ **A 935**  
adapter for pedestal



■ **A 936**  
8" european attachment



■ **A 961**  
8" european attachment to  
castle nut



■ **A 849**  
150mm bowl base converter



■ **A 865**  
pivoting rubber foot hd tripods



■ **A 890**  
lambda 3-axis hand-wheel



■ **A 831**  
track wheels



■ **A 854**  
150-100mm reduction ring



■ **A 849/M**  
150mm bowl base converter



■ **A 876**  
pivoting rubber foot - rubber loop



■ **A 882**  
lambda short pan bar



■ **A 883 L**  
lambda counterweight



■ **A 950**  
100/75mm reduction ring



■ **A 857**  
pivoting rubber foot dv/eng/efp  
tripods



■ **A 908**  
pivoting rubber foot studio  
tripods



■ **A 940**  
P50 pneumatic wheels



■ **A 915**  
spinhead counterweight





■ **A 918**  
smarthead counterweight



■ **A 867**  
P50 foot ring



■ **A 864**  
lambda camera plate



■ **A 932**  
master camera plate



■ **A 858/D**  
inverted camera plate  
spinhead & smarthead



■ **A 850/L**  
lambda eye piece  
extension holder



■ **A 858 / A 859**  
eng camera plate



■ **A 868**  
C60/omega dovetail plate



■ **A 933**  
master quick release plate



■ **A 904**  
long camera plate  
spinhead & smarthead



■ **A 850/MS**  
maxima/master/sigma eye piece  
extension holder



■ **A 860**  
efp camera plate



■ **A 884**  
removable universal plate



■ **A 895**  
sigma HD plate



■ **A 905**  
focus/hiDV camera plate



■ **A 920**  
spinhead long video plate



■ **A 850/C4 & A850/C2**  
C20S/C40S eye piece extension holder



■ **A 951**  
fast lock base



■ **C 911**  
dutch head fly case



■ **C 928**  
light soft bag



■ **A 921**  
DV quick release plate



■ **A 930**  
sigma short pan bar



■ **C 934**  
spinhead waterproof case



■ **A 920**  
lambda fly case



■ **C 929**  
hard bag with wheels



■ **A 922 - w/A 921**  
75mm ball base with quick release plate



■ **A 901**  
eng shoulder mount



■ **C 936**  
waterproof cube



■ **C 912**  
pvc transport tube



■ **C 939**  
waterproof tripod case w/wheels





**supports  
your  
vision**



**CARTONI's mission**  
**is to guarantee**  
**the cameraman the highest**  
**possible reliability,**  
**freedom and creativity**  
**in any environment.**

**CARTONI**

**supports  
your  
vision**

Cartoni S.p.A. stands behind each product with one year warranty and with an unprecedented five year warranty for each Professional Fluid Head against defects in materials and workmanship.  
Specifications are subject to change without notice.  
No liability can be accepted for any variation.

**CARTONI S.p.A.**

Via Giuseppe Mirri, 13 - 00159 Roma  
Tel. +39 06.4382002 - Fax +39 06.43588293  
e-mail: [cartoni@cartoni.com](mailto:cartoni@cartoni.com) - [www.cartoni.com](http://www.cartoni.com)